

Fibre Cement

Profile  
Detail

Duragroove™  
Fastener Positioning

Date Jan 2013  
Scale 1:20  
Detail No. ADGV\_001

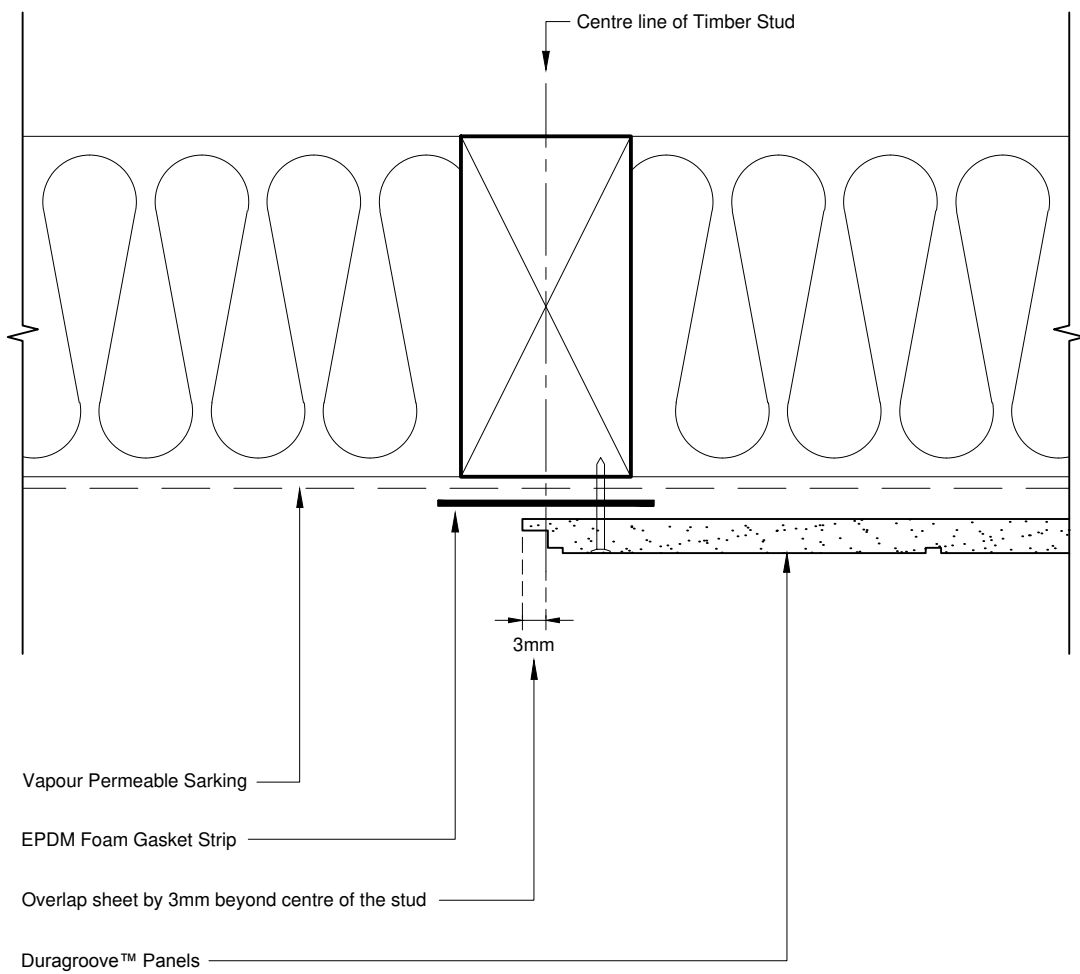

Fibre Cement

Profile  
Detail

Duragroove™  
Sheet Edge Positioning

Date Jan 2013  
Scale 1:2  
Detail No. ADGV\_003

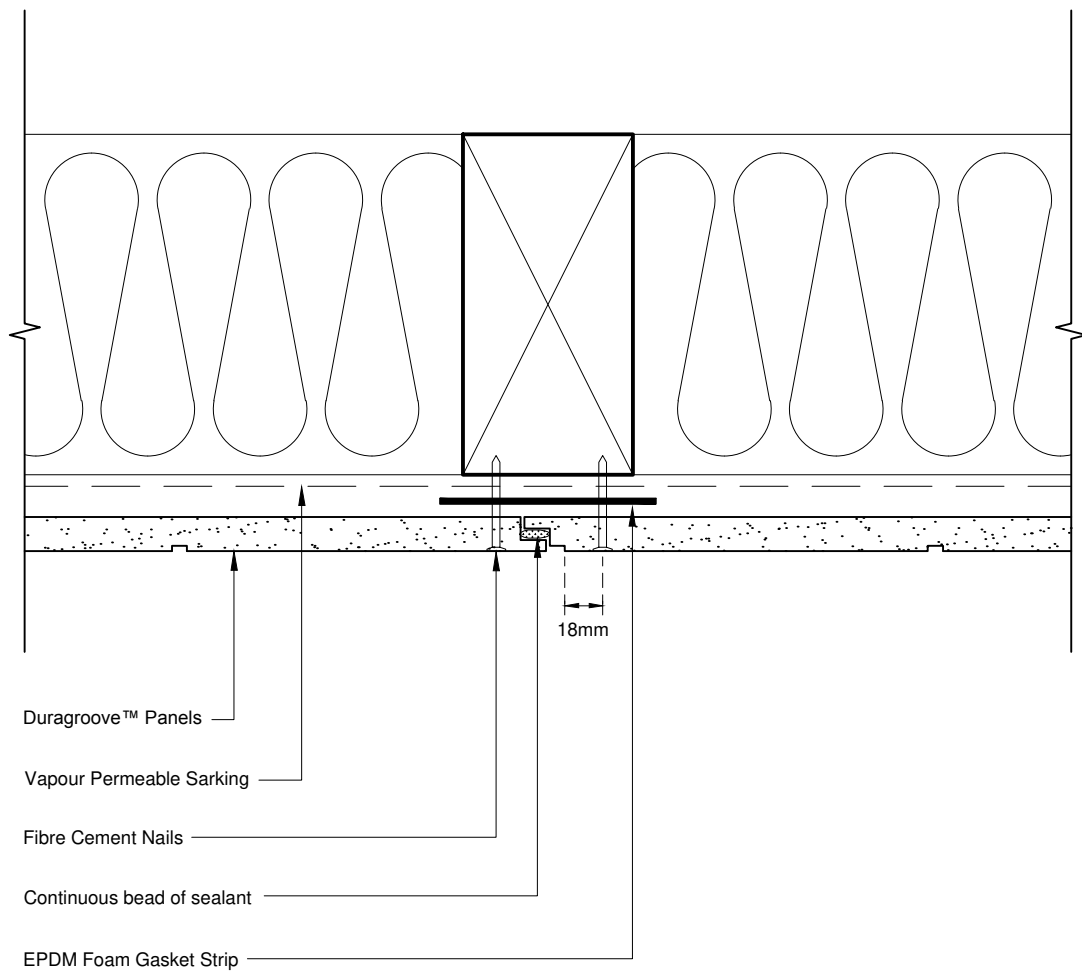

Fibre Cement

Profile  
Detail

Duragroove™  
F/C Nail Fixing-Timber Frame

Date Jan 2013  
Scale 1:2  
Detail No. ADGV\_004

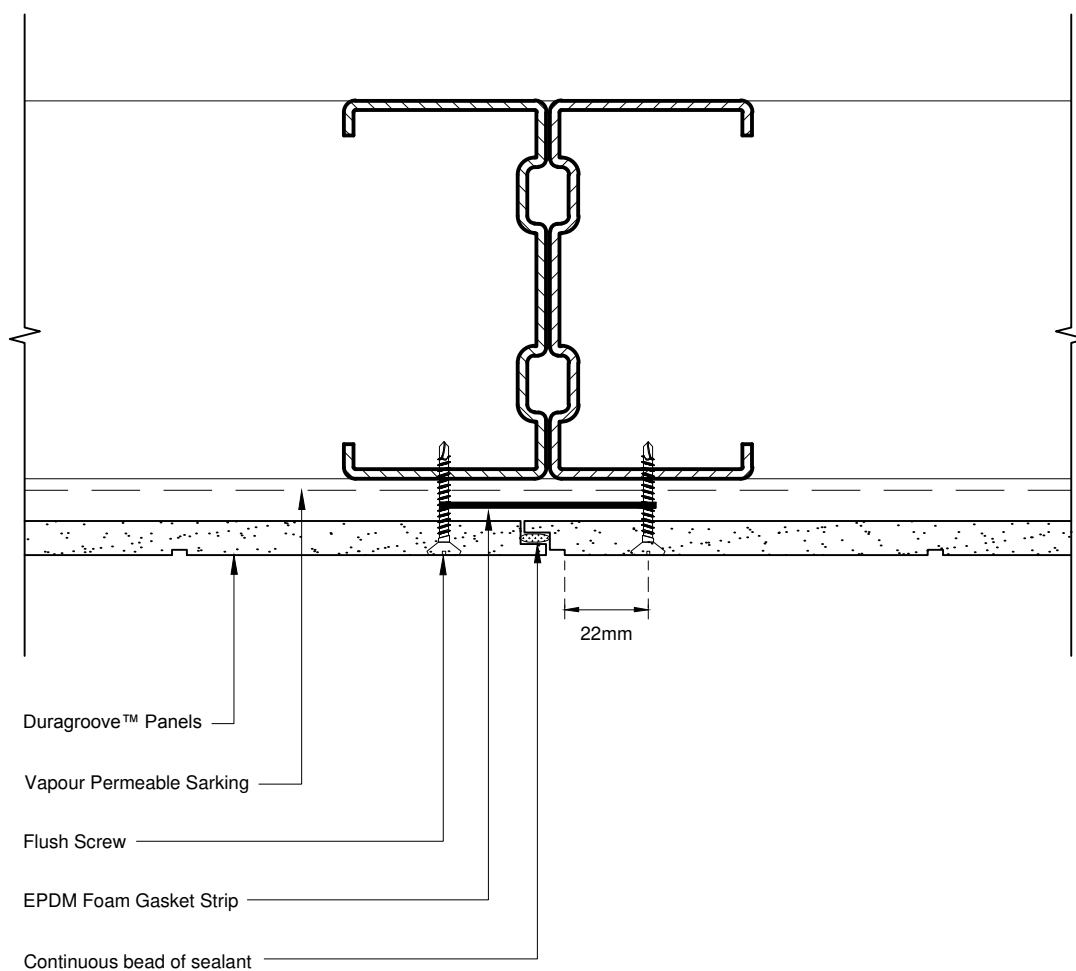

Fibre Cement

Profile  
Detail

Duragroove™  
Countersunk Screw-Lightweight Steel Frame

Date Jan 2013

Scale 1:2

Detail No. ADGV\_005

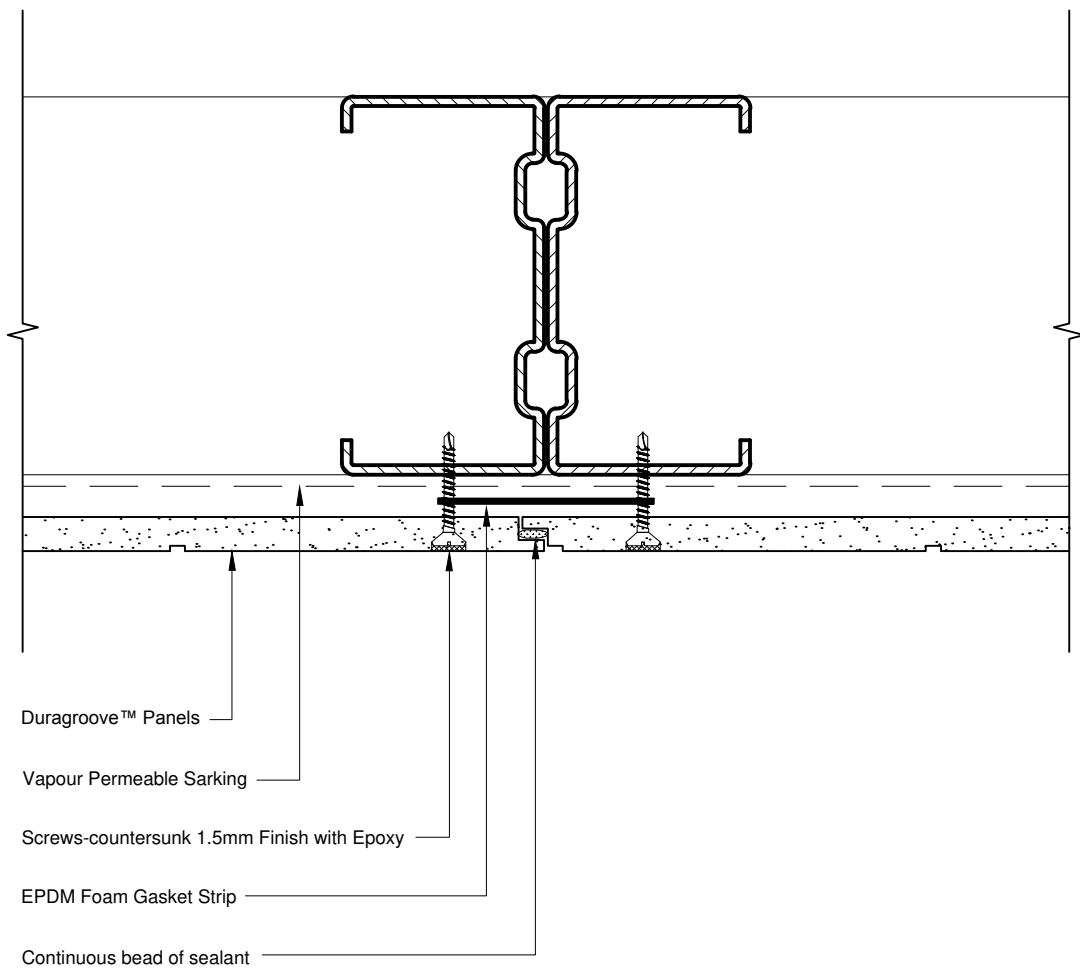

Fibre Cement

Profile  
Detail

Duragroove™  
Flush Screw-Lightweight Steel Frame

Date Jan 2013  
Scale 1:2  
Detail No. ADGV\_006

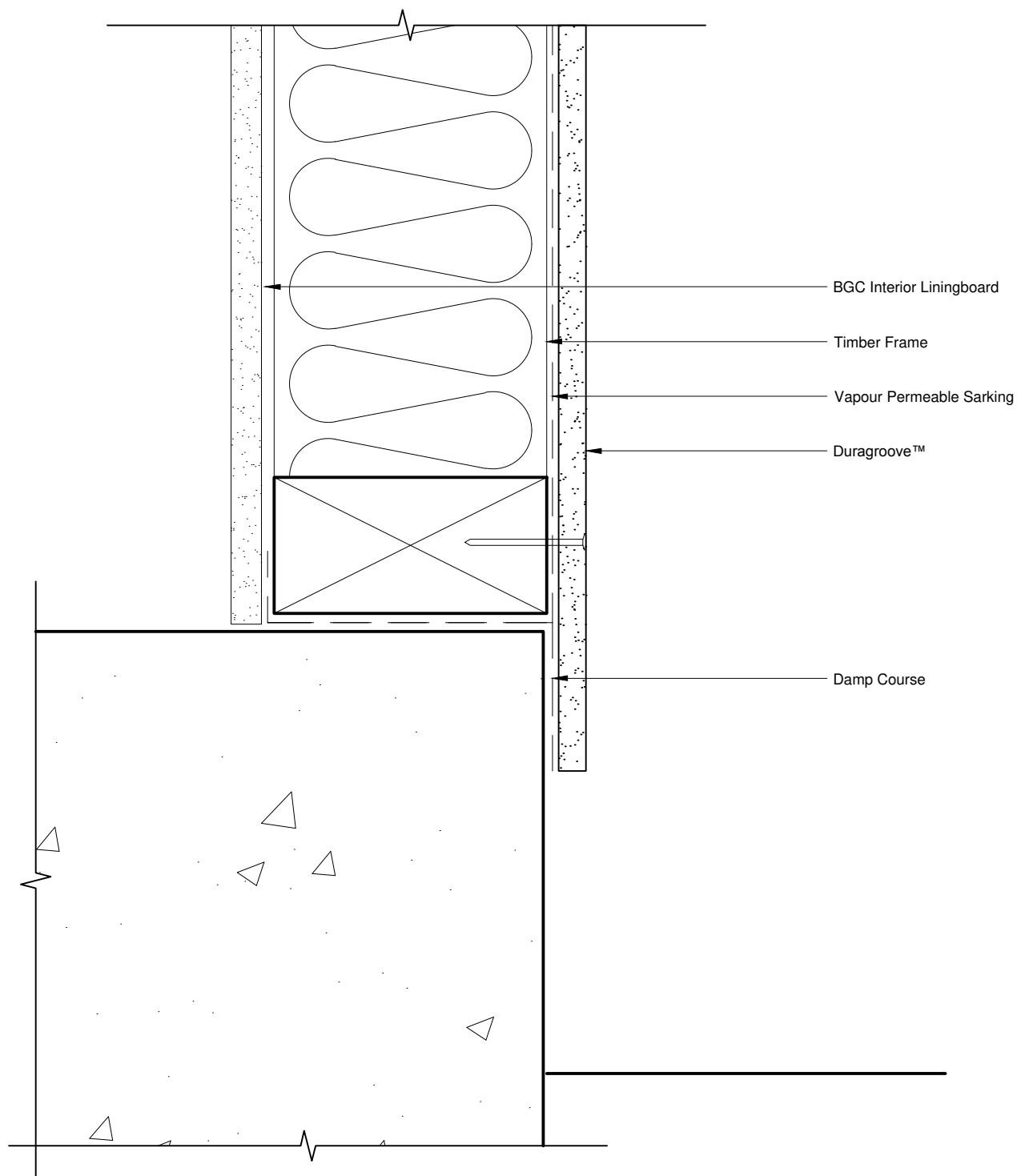

Fibre Cement

Profile  
Detail

Duragroove™  
Slab Edge/Eave Junction

Date Jan 2013

Scale 1:2

Detail No. ADGV\_010

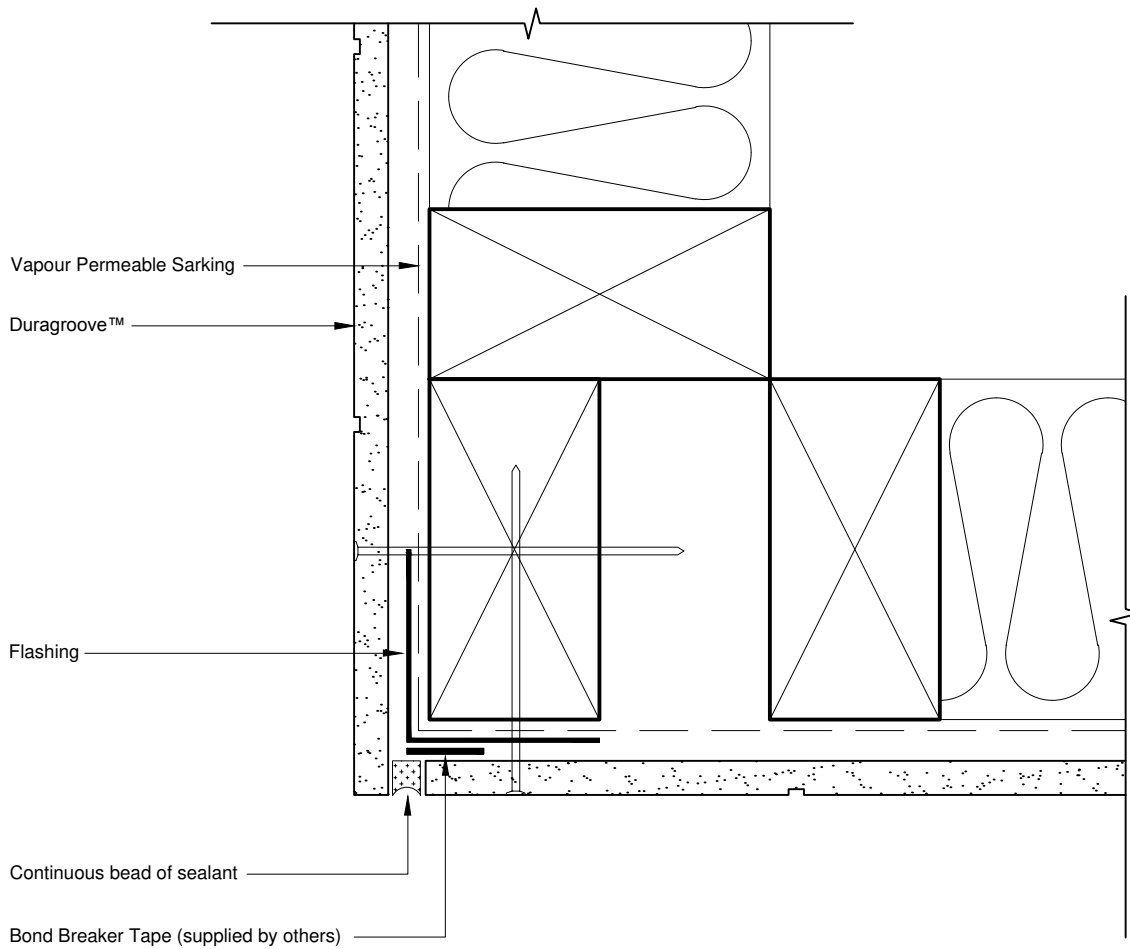

Fibre Cement

Profile  
Detail

Duragroove™  
External Corner-Sealant Option

Date Jan 2013

Scale 1:2

Detail No. ADGV\_011

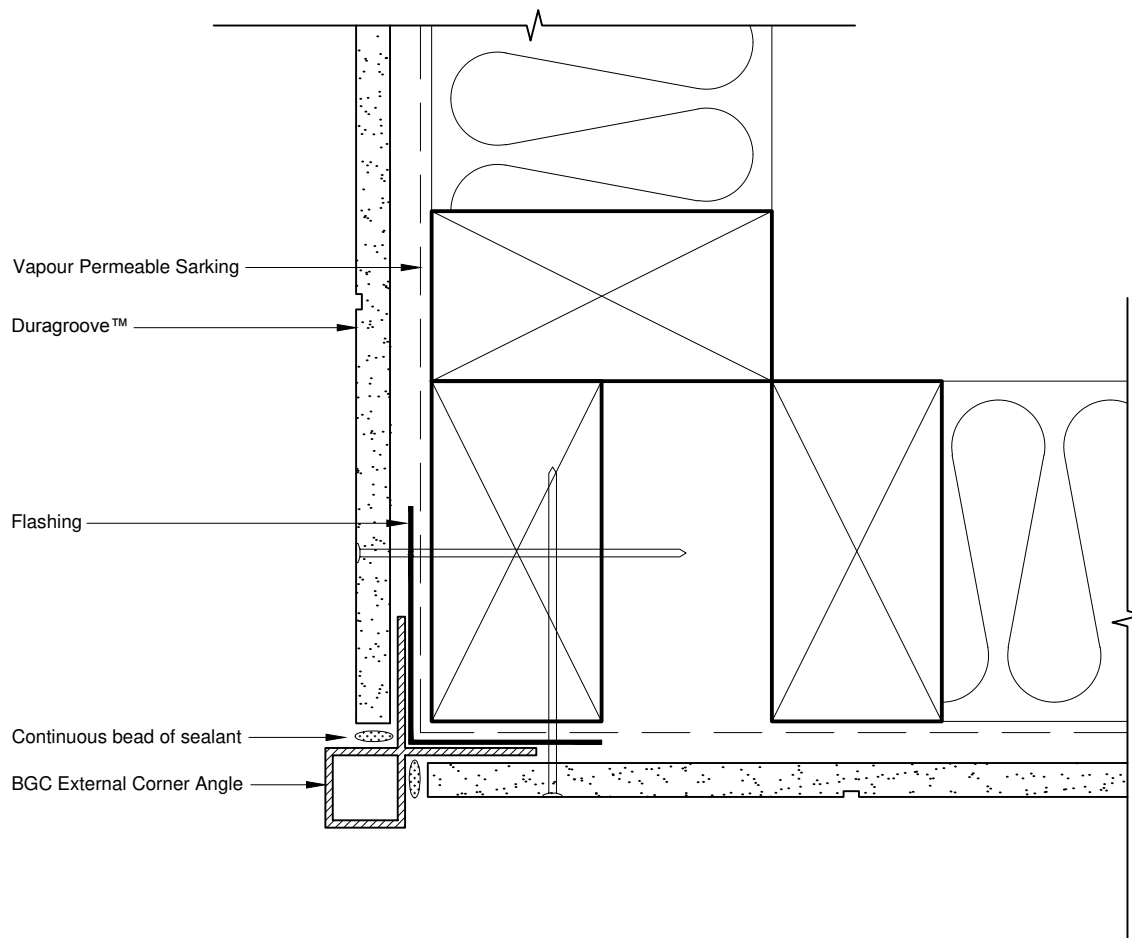

Fibre Cement

Profile  
Detail

Duragroove™  
External Corner-Aluminium

Date Nov 2014  
Scale 1:2  
Detail No. ADGV\_012



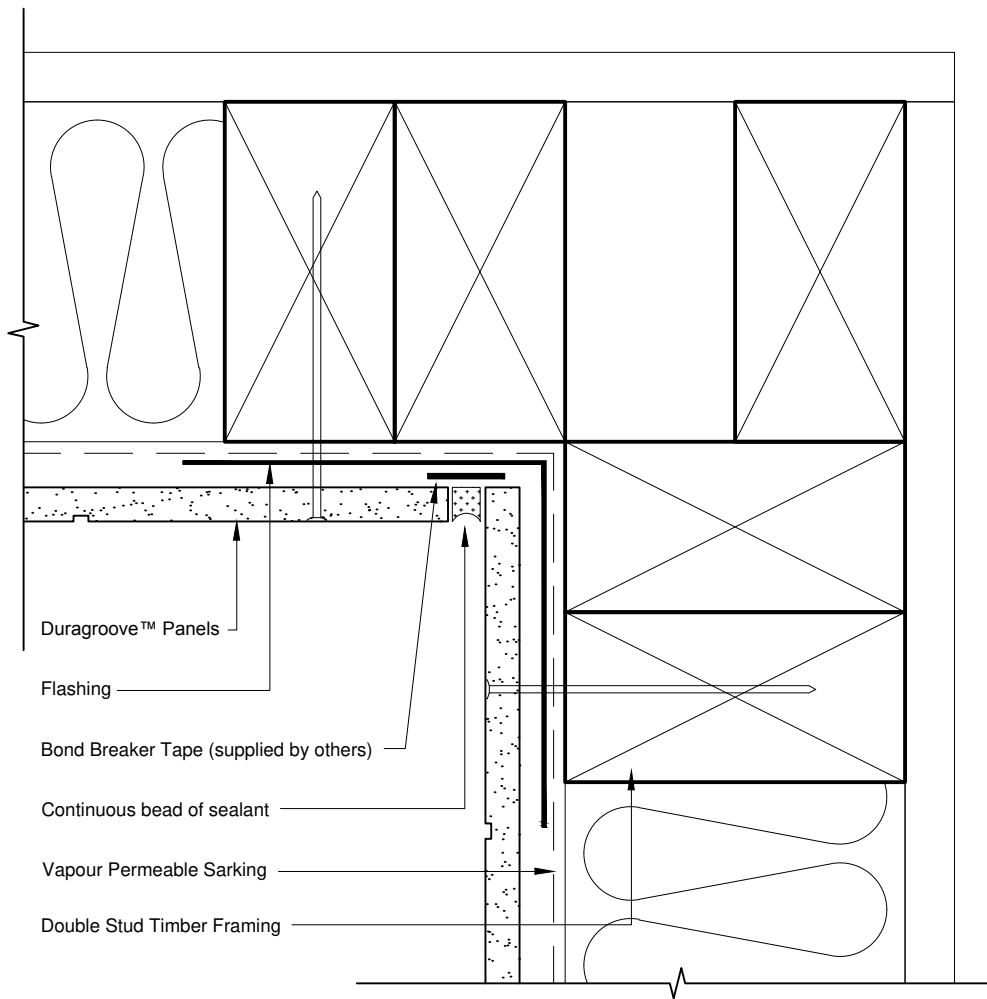

Fibre Cement

Profile  
Detail

Duragroove™  
Internal Corner-Sealant Option

Date Jan 2013

Scale 1:2

Detail No. ADGV\_013

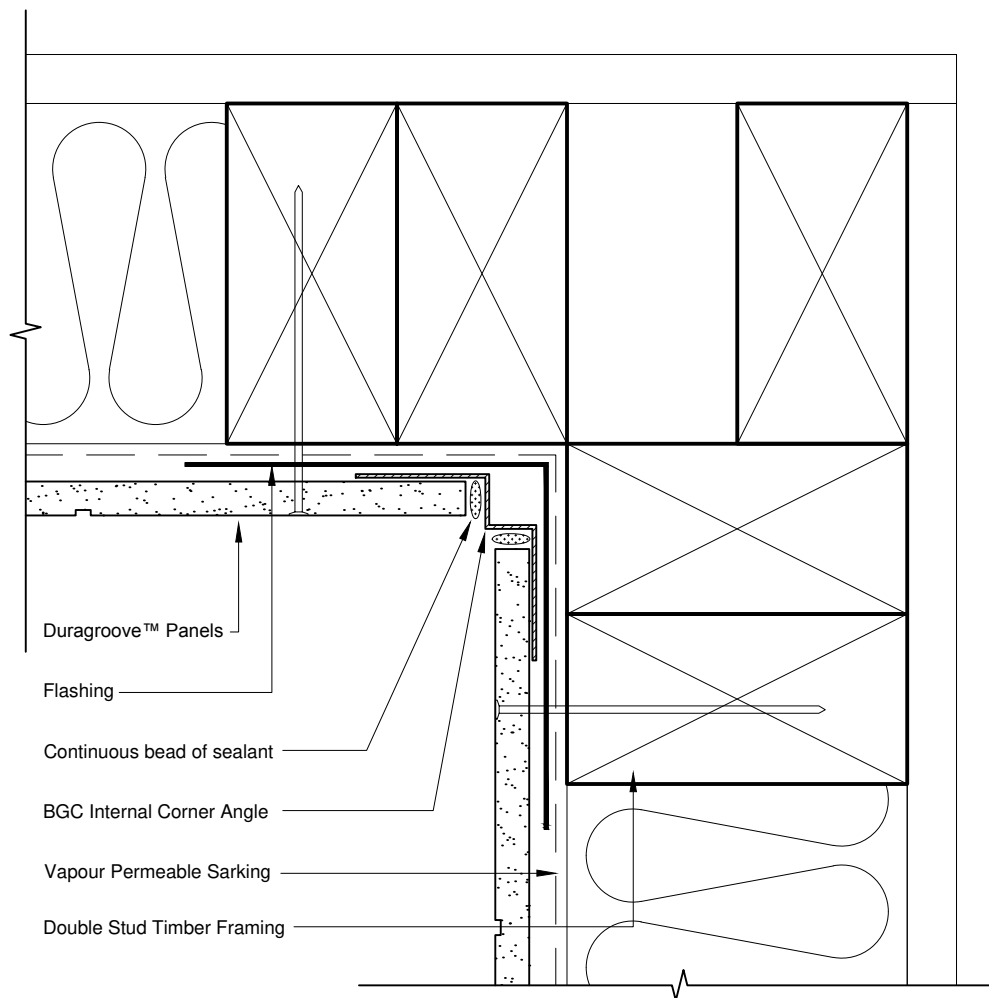

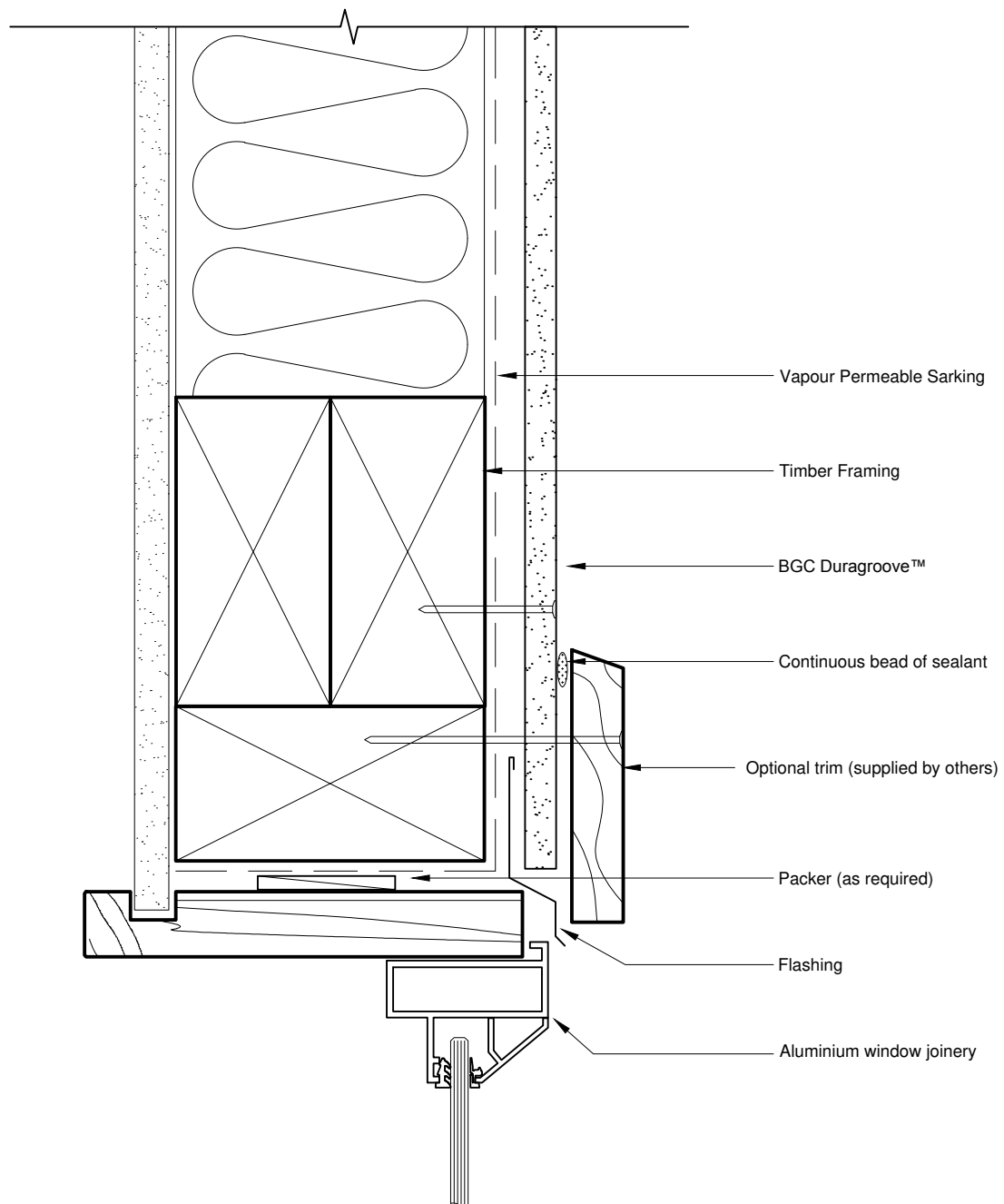

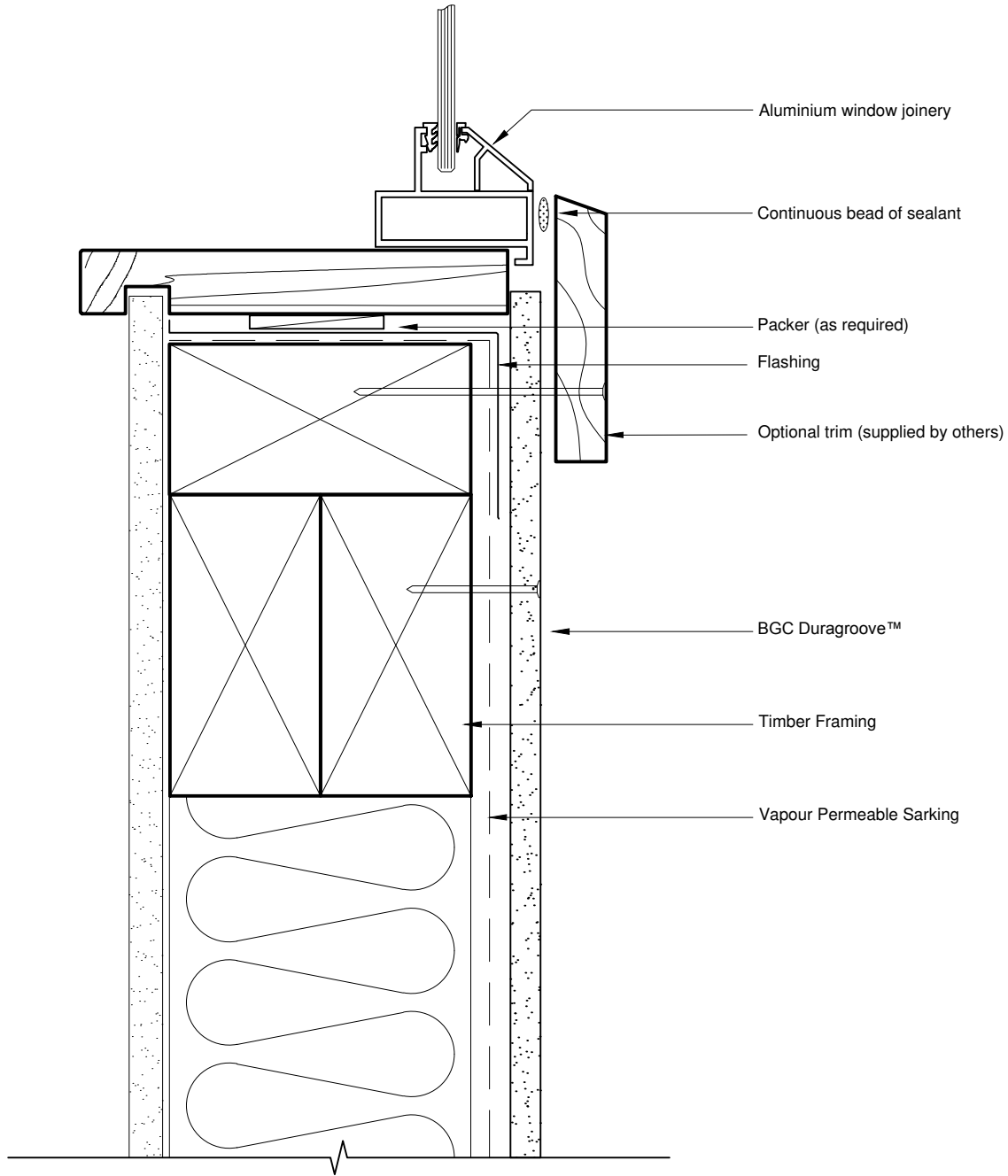

Fibre Cement

Profile  
Detail

Duragroove™  
Window Sill

Date Nov 2014

Scale 1:2

Detail No. ADGV\_016

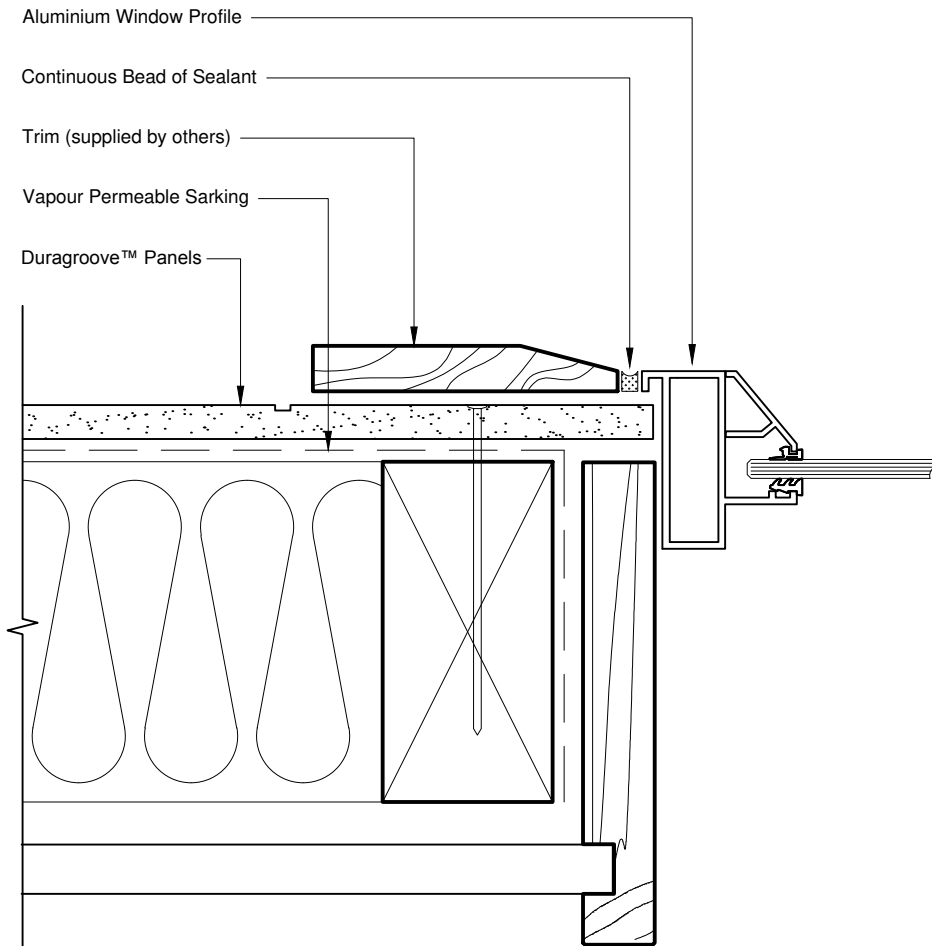

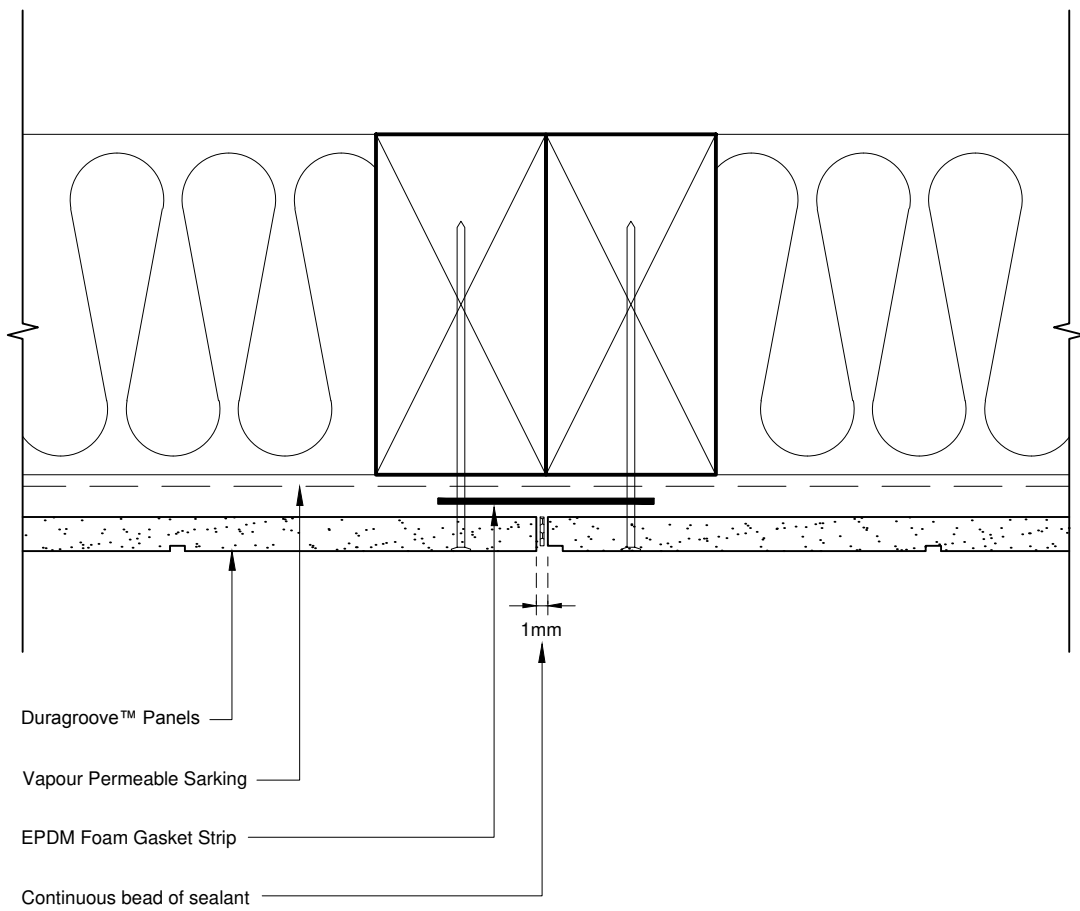

Fibre Cement

Profile  
Detail

Duragroove™  
Vertical Butt Joint

Date Jan 2013

Scale 1:2

Detail No. ADGV\_018

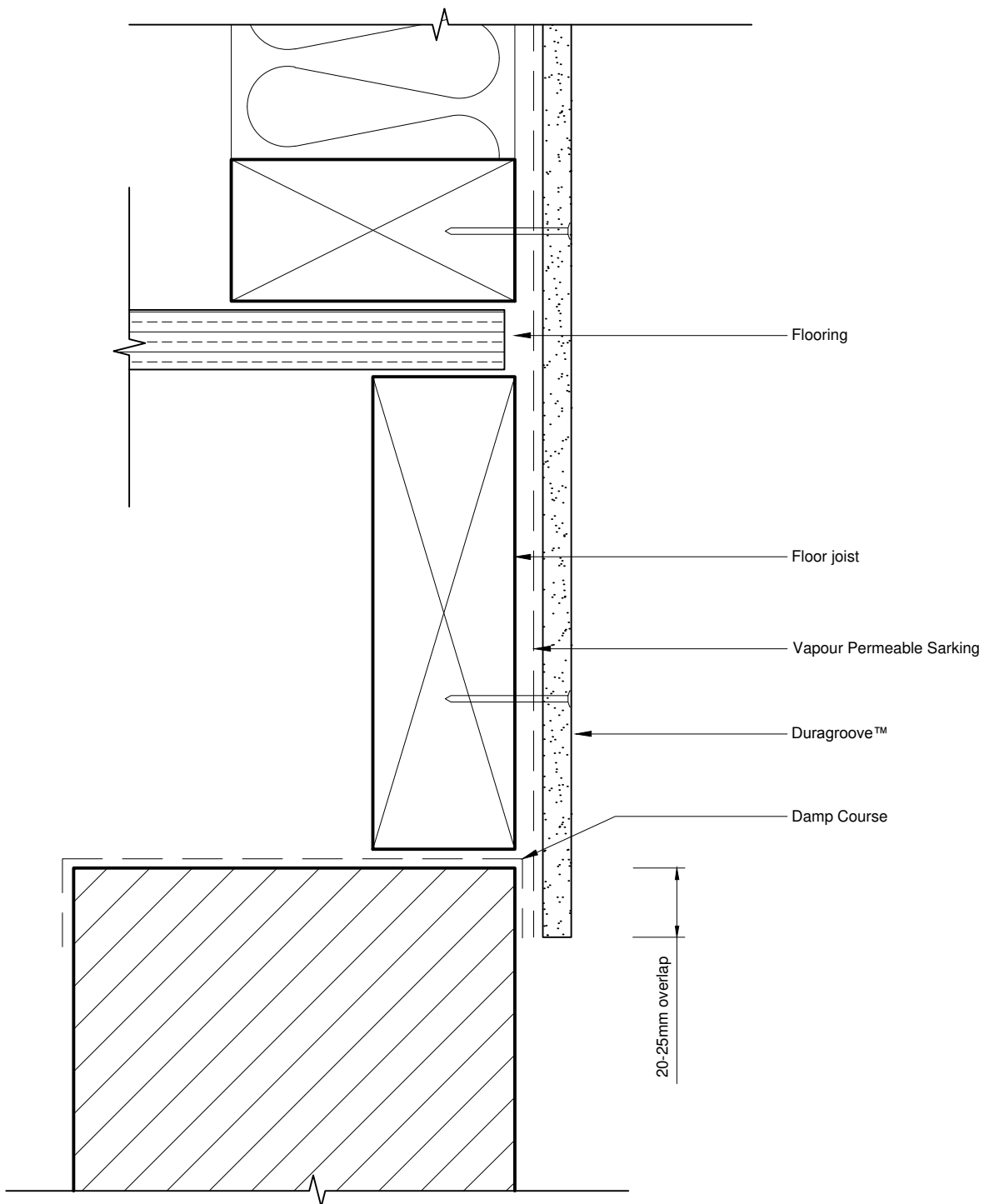

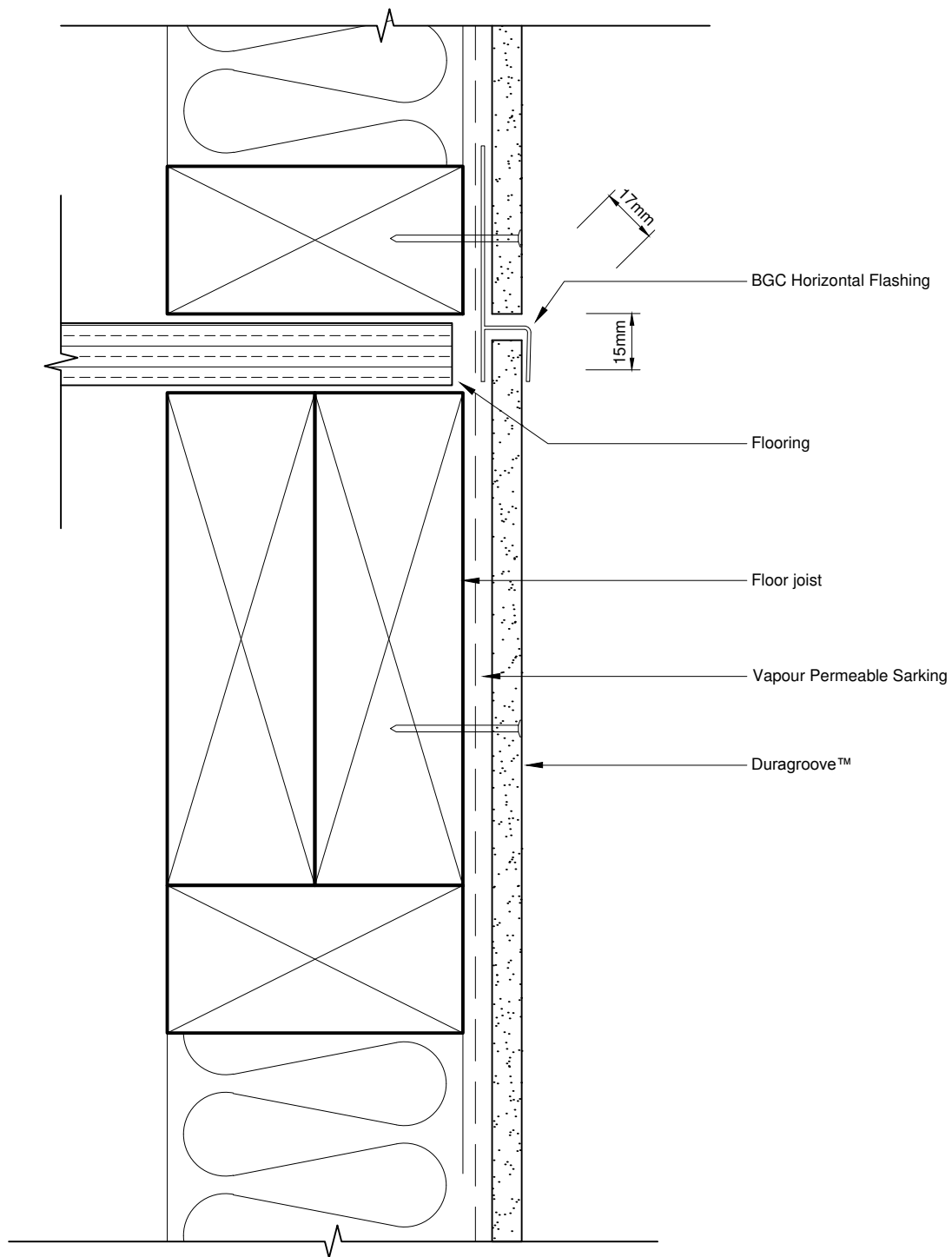



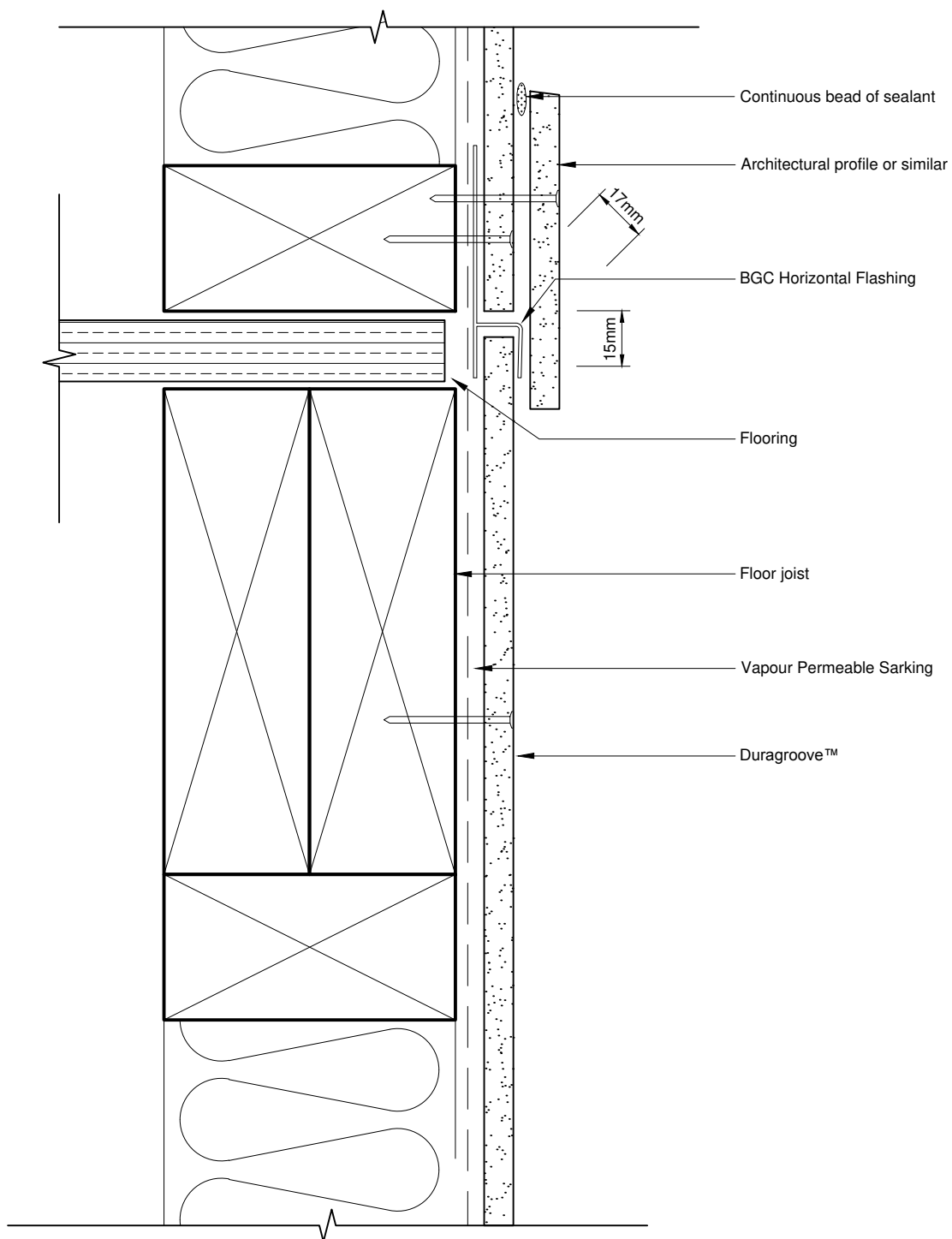

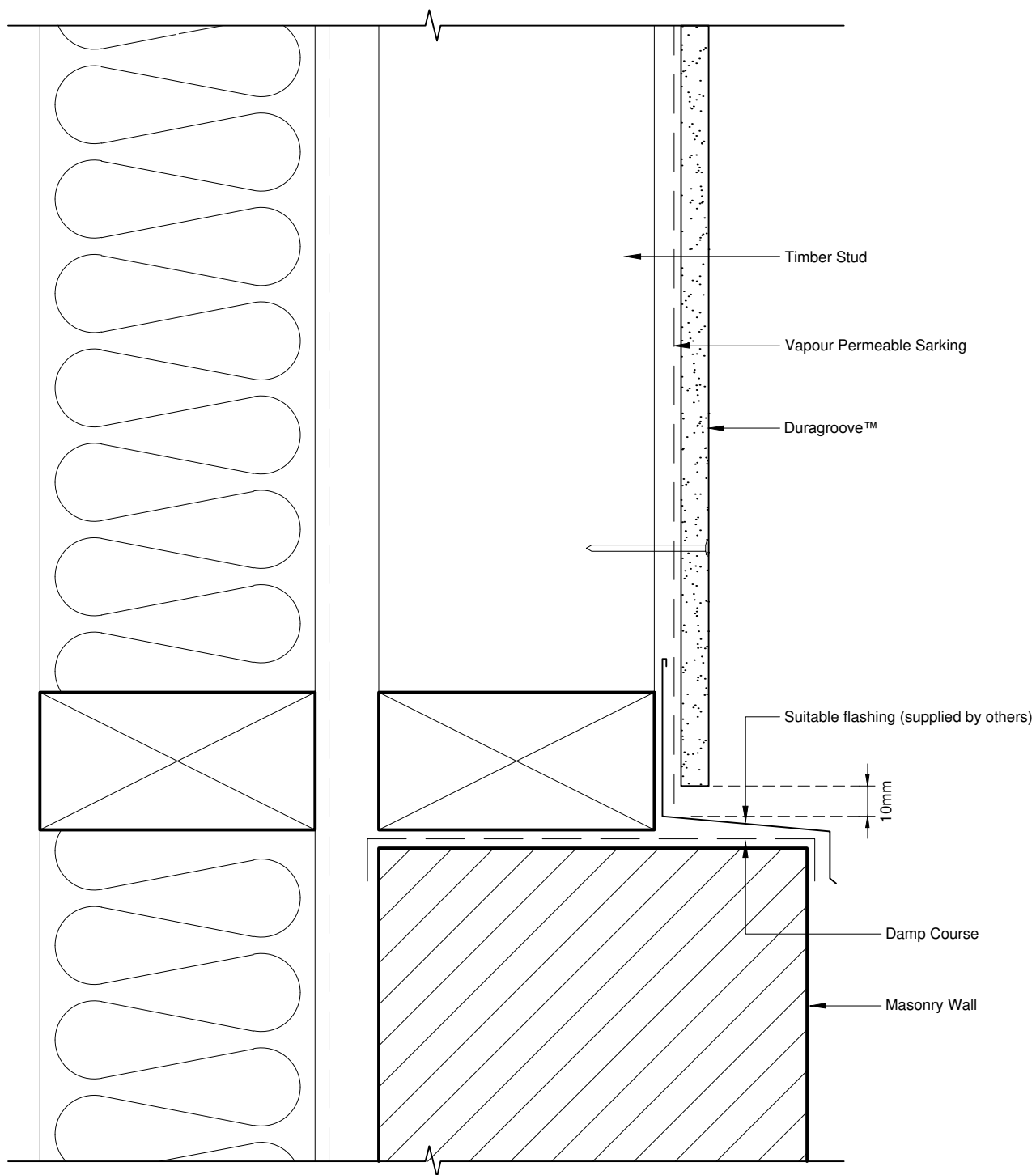

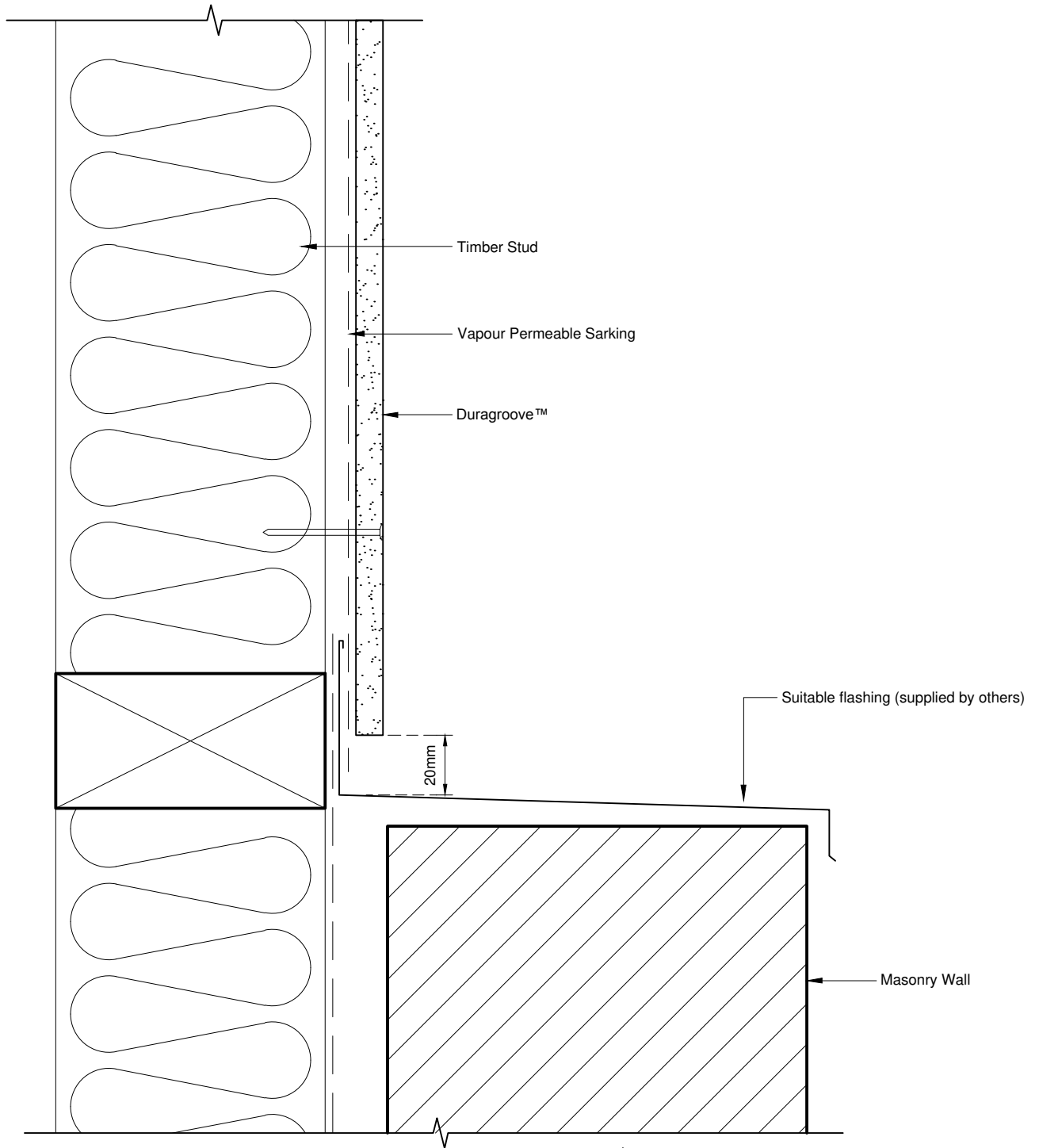

Fibre Cement

Profile  
Detail

Duragroove™  
Horizontal Junction-2

Date Jan 2013

Scale 1:2

Detail No. ADGV\_023

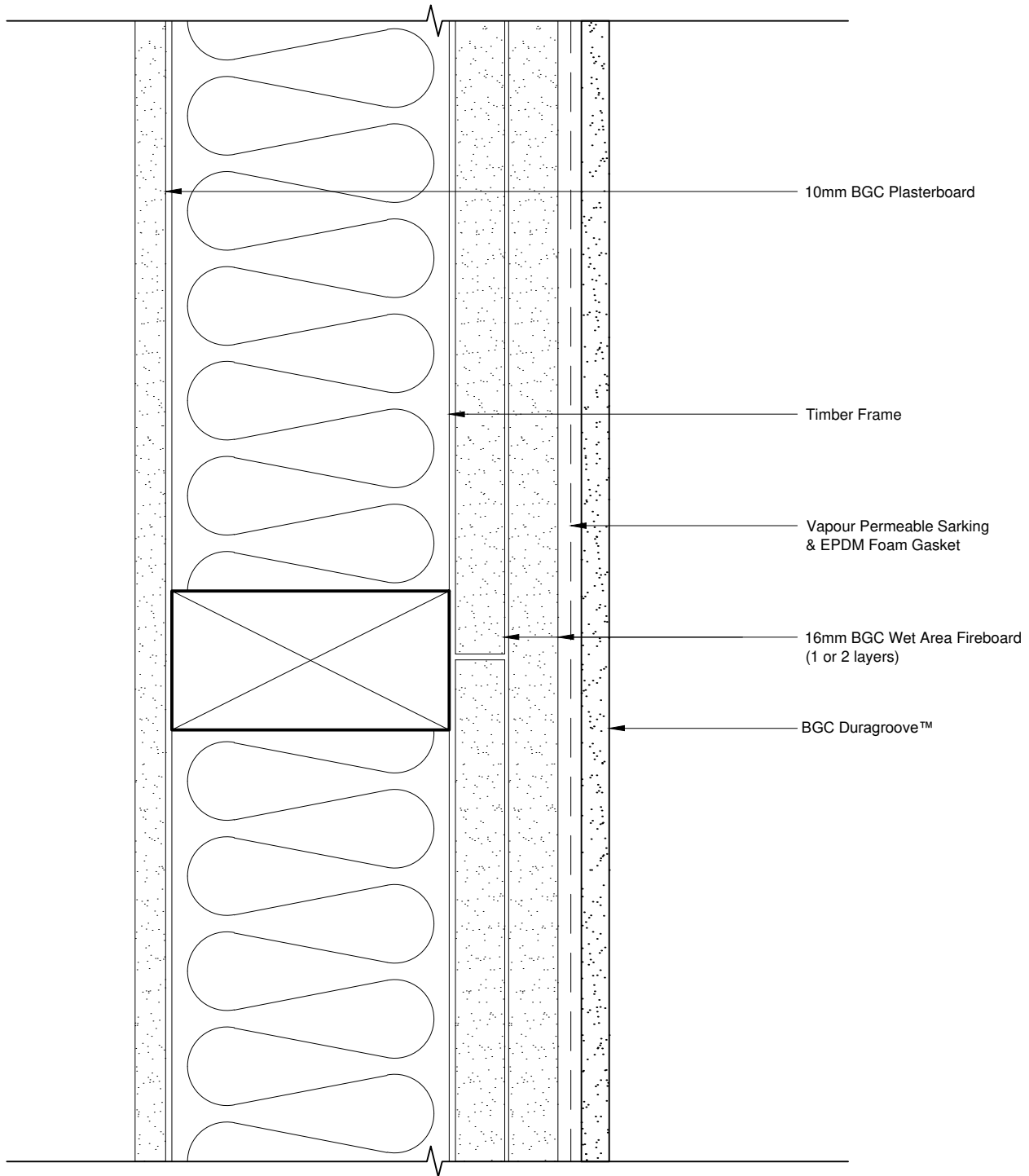

Fibre Cement

Profile  
Detail

Duragroove™  
Boundary Wall System

Date Jan 2013

Scale 1:2

Detail No. ADGV\_024

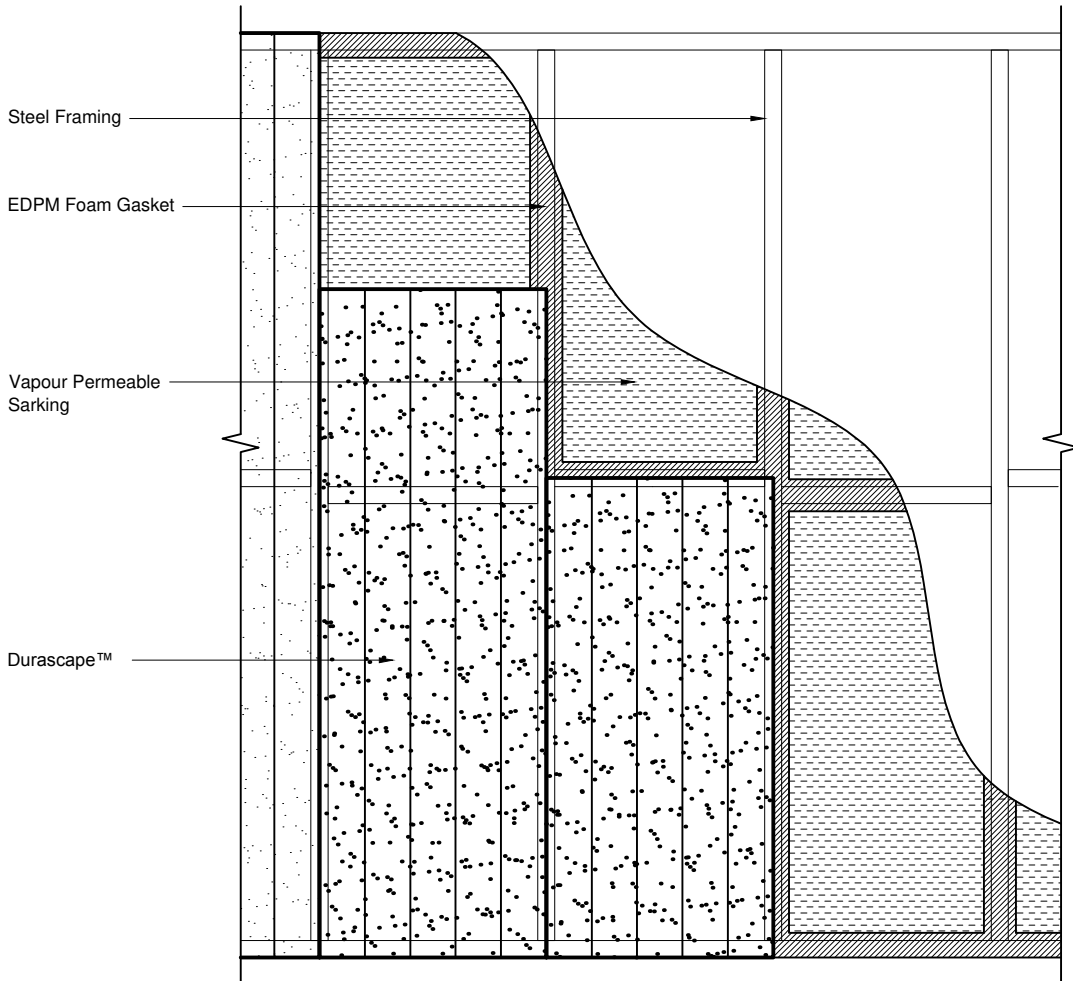

Fibre Cement

Profile  
Detail

Duragroove™  
Thermal Breaks

Date Nov 2014  
Scale 1:20  
Detail No. ADGV\_025